

APOIO[®]

MATERIAIS ELÉTRICOS



CATÁLOGO DE PRODUTOS



APOIO[®]

MATERIAIS ELÉTRICOS

50
Anos
DE ENERGIA POSITIVA

Toda a tradição na fabricação de materiais elétricos e sistemas de fixação se une ao conceito de modernidade.

Considerada pelos consumidores como uma marca jovem, arrojada e de alta qualidade.

INMETRO

5 ANOS
DE GARANTIA
100% BRASILEIRO



LISSÊ CONNECT

Trás mais liberdade na hora da escolha, com apenas 1 linha de módulo você consegue utilizar 5 opções de acabamento:

Linha Modular, Linha Modular Black, Sobrepor, Móveis e Conduletes.

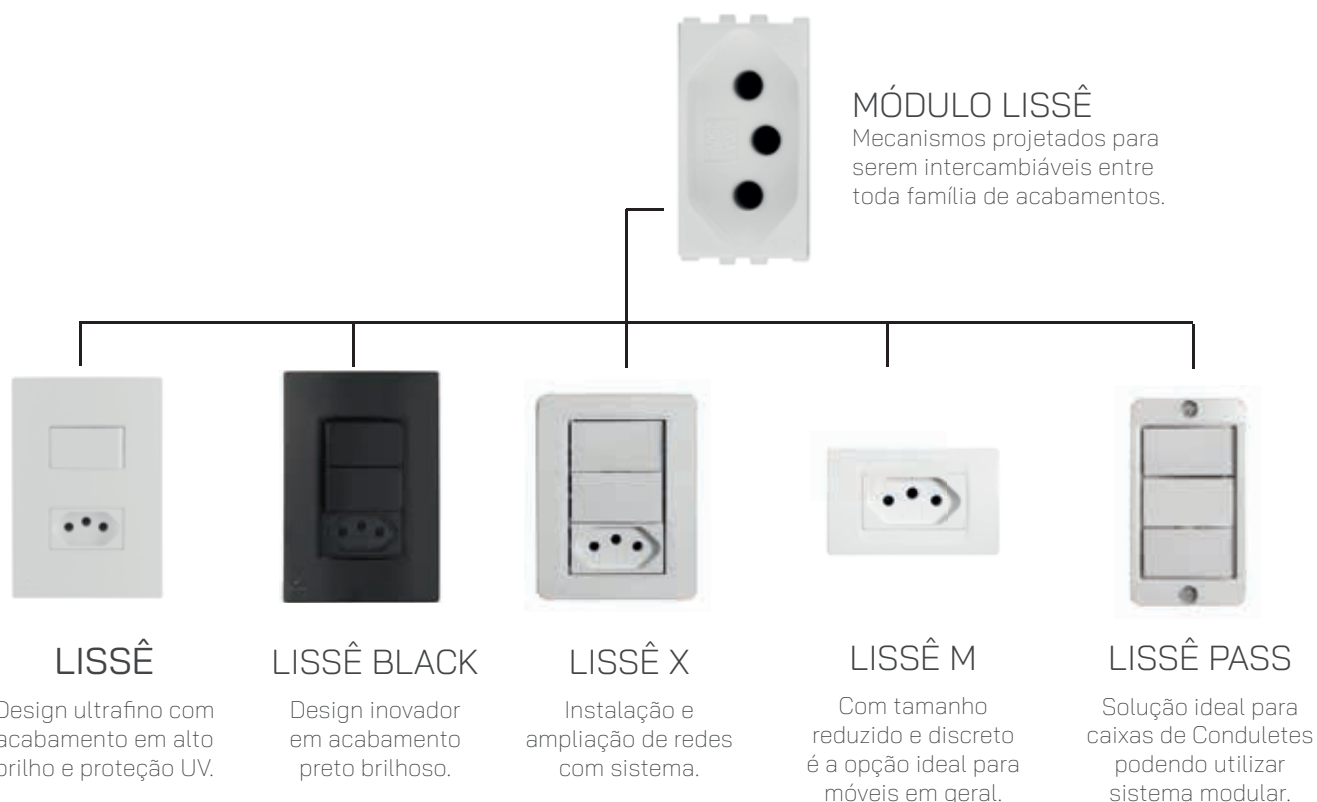

SUMÁRIO

Linhas Modulares

Lissê Black	05
Lissê	08
Lissê.X	11
Lissê.Pass	11
Lissê.M	11
Modoluz	12
Volutta	15

Linhas Bianca e Externa

Bianca	18
XB	22

Medidas, Acessórios e fixação

Medidas	24
Acessórios	27
Apoio.Fix	30

linha **Lissê** **black**

5 ANOS
DE GARANTIA
100% BRASILEIRO

ULTRA FINO

Placas com 3mm em relação a parede.

ALTA RESISTÊNCIA

Acabamento em alto brilho, com a melhor resistência e durabilidade.

DESIGN MODERNO

Cantos levemente arredondados para melhor adequação a todos os ambientes.

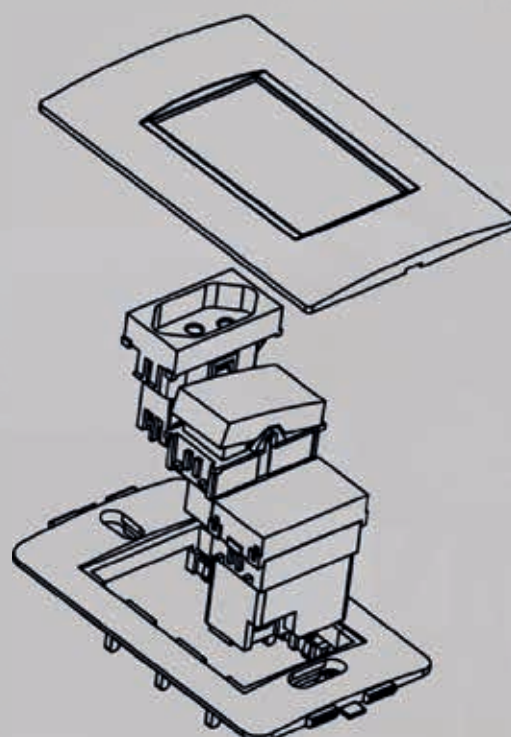

CONJUNTOS MONTADOS E PLACAS



LP7001 - 10A
Interruptor Simples
LP2011 - 10A
Interruptor Paralelo
LP2111 - 10A
Interruptor Bipolar Paralelo



LP2031 - 10A
Pulsador de Minuteria



LP2131 - 10A
Interruptor Bipolar Simples



LP2021-10A
Pulsador de Campanha



LP2151 - 25A
Interruptor Bipolar Simples



LP2201 - 10A
3 Interruptores Simples
LP2211 - 10A
3 Interruptores Paralelos
LP7043 - 10A
1 Interruptor Simples + 2 Interruptores Paralelos



LP2101 - 10A
2 Interruptores Simples
LP2121 - 10A
2 Interruptores Paralelos
LP7011 - 10A
1 Interruptor Simples + 1 Interruptor Paralelo



LP7301 - 10A
LP7801 - 20A
1 Interruptor Simples + Tomada 2P+T
LP7311 - 10A
LP7811 - 20A
1 Interruptor Paralelo + Tomada 2P+T



LP8001 - 10A
2 Interruptores Simples + Tomada 2P+T
LP8011 - 10A
2 Interruptores Paralelos + Tomada 2P+T



LP7401 - 10A
LP7601 - 20A
Tomada 2P+T Horizontal



LP7501 - 10A
Tomada 2P+T Vertical



LPV7601 - 20A
Tomada 2P+T Vermelha



LP3601 - 10A
LP4601 - 20A
2 Tomadas 2P+T



LP5601 - 10A
3 Tomadas 2P+T



LP0023
Tomada RJ11



LP0024
Tomada RJ45



LP0025 - 2.1A
Tomada USB 2,1A 5V



LP4210
Campanha Bivolt Automático

LP7200
Placa 4x2
Cega



LP7204
Placa 4x2
p/ 1 Módulo
Horizontal



LP7201
Placa 4x2
p/ 1 Módulo
Vertical



LP7202
Placa 4x2
p/ 2 Módulos



LP7203
Placa 4x2
p/ 3 Módulos



LP7207
Placa 4x2
com Furo
ø10mm



LP7211
Placa 4x2 p/
2 Módulos
Distanciados



LP7440
Placa 4x4
Cega



LP7442
Placa 4x4
p/ 2 Módulos



LP7443
Placa 4x4
p/ 6 Módulos



LP7445
Placa 4x4
p/ 4 Módulos
Distanciados



LP7444
Placa 4x4
p/ 4 Módulos



LP7000 - 10A
Módulo
Interruptor
Simples
LP7110 - 10A
Módulo
Interruptor
Bipolar Paralelo

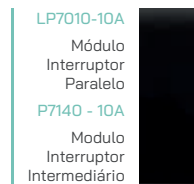

LP7020 - 10A
Módulo
Pulsador de
Campainha



LP7030 - 10A
Módulo
Pulsador de
Minuteria

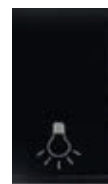

LP7130 - 10A
Módulo
Interruptor
Bipolar
Simples



LP7400 - 10A
LP7600 - 20A
Módulo Tomada
2P+T



LV7600 - 20A
Módulo
Tomada 2P+T
Vermelho



LPUSB7822
Módulo USB
Bivolt 2,1A 5V



LP7817
Módulo RJ11



LP7818
Módulo RJ45



LP7220
Módulo para
Cabo Coaxial



LP7213
Módulo com
Furo ø10mm

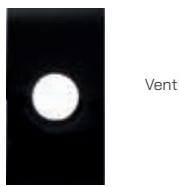

LP7619
Módulo
Controle de
Ventilador Bivolt
Automático



LP7618
Módulo
Dimmer Bivolt
Automático



LP7212
Módulo Cego



LP7819
Módulo
Campainha
Bivolt
Automático

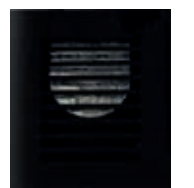

*Todas as placas acompanham suporte

linha Lissê

5 ANOS
DE GARANTIA
100% BRASILEIRO



NÃO AMARELA



ULTRA FINO

Placas com 3mm em relação a parede.

SISTEMA MODULAR

Fácil de intercambiar entre os módulos disponíveis! Incrementando as possibilidades de customizações.

DESIGN MODERNO

Cantos levemente arredondados para melhor adequação a todos os ambientes.



Tabela de medidas

Pág 24

L7001 - 10A
Interruptor
Simples
L2011 - 10A
Interruptor
Paralelo
L2111 - 10A
Interruptor
Bipolar
Paralelo

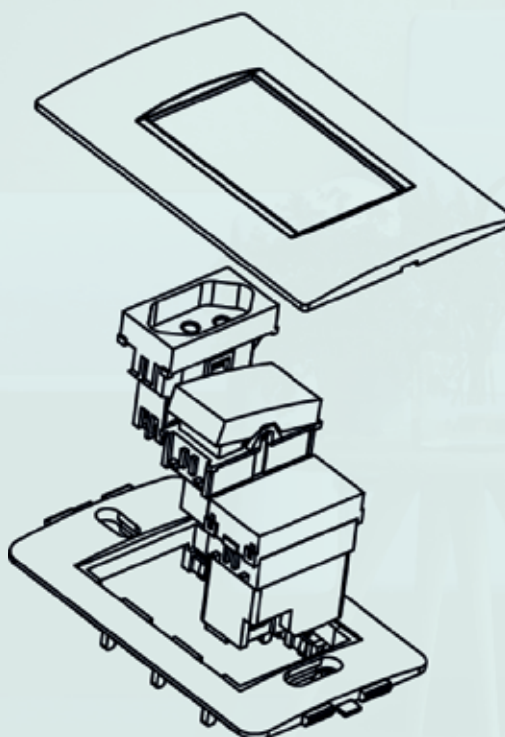

L2131 - 10A
Interruptor
Bipolar
Simples



L2021-10A
Pulsador de
Campainha



L2031 - 10A
Pulsador de
Minuteria



L2151 - 25A
Interruptor
Bipolar
Simples



L2201 - 10A
3 Interruptores
Simples
L2211 - 10A
3 Interruptores
Paralelos
L7043 - 10A
1 Interruptor
Simples +
2 Interruptores
Paralelos



L2101 - 10A
2 Interruptores
Simples
L2121 - 10A
2 Interruptores
Paralelos
L7011 - 10A
1 Interruptor
Simples +
1 Interruptor
Paralelo



L7501 - 10A
Tomada 2P+T
Vertical



L7301 - 10A
L7801 - 20A
Interruptor
Simples +
Tomada 2P+T
L7311 - 10A
L7811 - 20A
Interruptor
Paralelo +
Tomada 2P+T



L8001 - 10A
2 Interruptores
Simples +
Tomada 2P+T
L8011 - 10A
2 Interruptores
Paralelos +
Tomada 2P+T



L7401 - 10A
L7601 - 20A
Tomada 2P+T
Horizontal



L3601 - 10A
L4601 - 20A
2 Tomadas
2P+T



L5601 - 10A
3 Tomadas
2P+T



LV7601 - 20A
Tomada 2P+T
Vermelha



L4210
Campainha
Bivolt
Automático



L0023
Tomada RJ11



L0025 - 2.1A
Tomada USB
2.1A 5V



L0024
Tomada RJ45

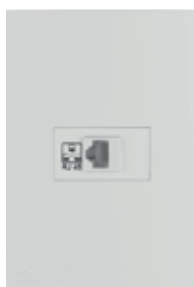



L7200
Placa 4x2
Cega



L7201
Placa 4x2
p/ 1 Módulo
Vertical



L7202
Placa 4x2
p/ 2 Módulos



L7203
Placa 4x2
p/ 3 Módulos



L7204
Placa 4x2
p/ 1 Módulo
Horizontal



L7207
Placa 4x2
com Furo
ø10mm



L7211
Placa 4x2
p/ 2 Módulos
Distanciados



L7445
Placa 4x4
p/ 4 Módulos
Distanciados



L7440
Placa 4x4
Cega



L7442
Placa 4x4
p/ 2 Módulos



L7443
Placa 4x4
p/ 6 Módulos



L7444
Placa 4x4
p/ 4 Módulos



L7010 - 10A
Módulo
Interruptor
Paralelo



L7110 - 10A
Módulo
Interruptor
Bipolar
Paralelo



L7140 - 10A
Módulo
Interruptor
intermediário



L7000 - 10A
Módulos
Interruptor
Simples



L7020 - 10A
Módulo
Interruptor de
Campainha



L7030 - 10A
Módulo
Pulsador de
Minuteria

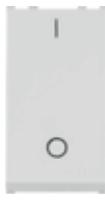

L7130 - 10A
Módulo
Interruptor
Bipolar Simples



L7400 - 10A
L7600 - 20A
Módulo
Tomada
2P+T



LV7600 - 20A
Módulo
Tomada 2P+T
Vermelho



LUSB7822
Módulo USB
Bivolt
2,1A 5 V



L7817
Módulo RJ11



L7818
Módulo RJ45



L7220
Módulo p/
Cabo Coaxial



L7618
Módulo Dimmer
Bivolt
Automático



L7619
Módulo Controle de
Ventilador
Bivolt
Automático



L7213
Módulo
com Furo
ø10mm



L7212
Módulo
Cega



L7819
Módulo Campainha
Bivolt Automático

linha
Lissê.pass

Placas para Condutele

LPB4200
Placa para Condutele Cega (Branco)



LPB5203
Placa para Condutele p/ 3 Módulos (Branco)



LPC4200
Placa para Condutele Cega (Cinza)



LPC5203
Placa para Condutele p/3 Módulos (Cinza)

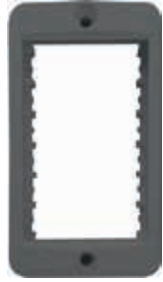

LPP4200
Placa para Condutele Cega (Preto)



LPP5203
Placa para Condutele p/ 3 Módulos (Preto)

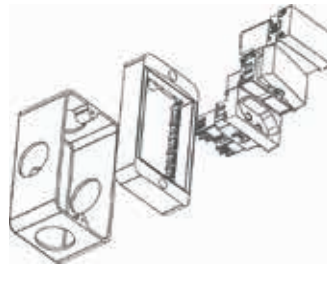

- AUMENTA O ESPAÇO INTERNO FACILITANDO A INSTALAÇÃO (17mm)
- SISTEMA MODULAR DE CONDULETES
- ADAPTÁVEL AS PRINCIPAIS CAIXINHAS DO MERCADO

linha
Lissê.X

Caixas de Sobrepor Modulares

LX5201
Caixa Sobrepor + Placa p/ 1 Módulo



LX5202
Caixa Sobrepor + Placa p/ 2 Módulos



LX5203
Caixa Sobrepor + Placa p/ 3 Módulos



LXP5201
Caixa Sobrepor + Placa p/ 1 Módulo



LXP5202
Caixa Sobrepor + Placa p/ 2 Módulos



LXP5203
Caixa Sobrepor + Placa p/ 3 Módulos

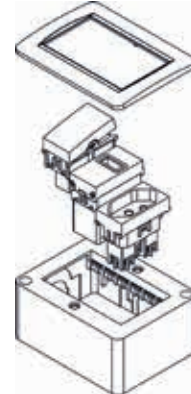

LX4200
Caixa Sobrepor + Placa Cega Pequena



LXP4200
Caixa Sobrepor + Placa Cega Pequena

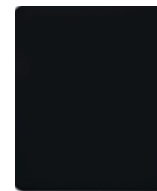

LX5200
Caixa Sobrepor + Placa Cega Grande



LXP5200
Caixa Sobrepor + Placa Cega Grande

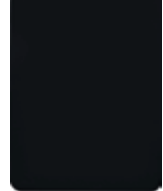

linha
Lissê.m

Suporte para móveis

LM5201
Placa + Suporte para Móveis p/ 1 Módulo



LMP5201
Placa + Suporte para Móveis p/ 1 Módulo

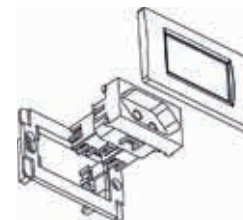

linha Moduluz

5 ANOS
DE GARANTIA
100% BRASILEIRO



FÁCIL CUSTOMIZAÇÃO

Desenvolvida especialmente para quem não abre mão de beleza e qualidade, sem querer pagar mais por isso.

SISTEMA MODULAR

A linha Moduluz, possibilita diversas instalações.

DESIGN MODERNO

Prática, segura, com design moderno e de fácil instalação.

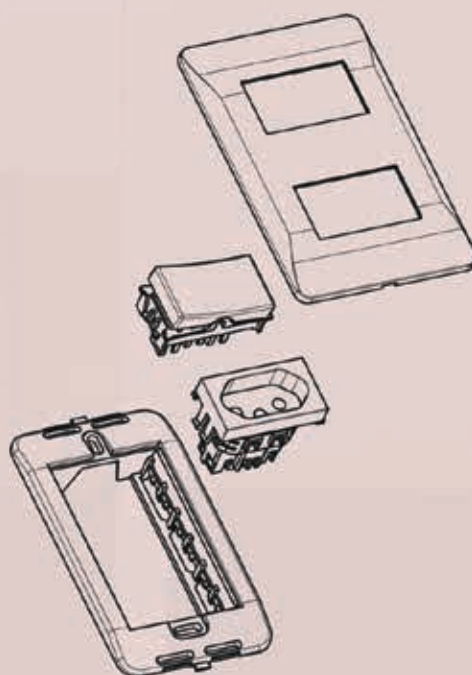

MA7001 - 10A

Interruptor
Simples



MA2011 - 10A

Interruptor
Paralelo



MA2111 - 10A

Interruptor
Bipolar
Paralelo



MA2151 - 25 A

Interruptor Bipolar
Simples



MA2101 - 10A

2 Interruptores
Simples



MA2121 - 10A

2 Interruptores
Paralelos



MA7011 - 10A

1 Interruptor Paralelo
+ 1 Interruptor Simples



MA2021 - 10 A

Pulsador de
Campainha



MA2031 - 10A

Pulsador de
Minuteria



MA2131 - 10 A

Interruptor
Bipolar Simples



MA2201 - 10 A

3 Interruptores Simples



MA7043 - 10 A

2 Interruptores Paralelos +
1 Interruptor Simples



MA2211 - 10 A

3 Interruptores Paralelos



MA7301 - 10 A

1 Interruptor Simples
+ 1 Tomada 2P+T



MA7311 - 10 A

1 Interruptor Paralelo
+ 1 Tomada 2P+T



MA8001 - 10 A

2 Interruptores Simples
+ 1 Tomada 2P+T



MA8011 - 10 A

2 Interruptores Paralelos
+ 1 Tomada 2P+T



MA7401 - 10 A

MA7601 - 20 A

Tomada 2P+T
Horizontal



MA3601 - 10 A

2 Tomadas 2P+T



MA7501 - 10A

1 Tomada 2P+T
Vertical



MA0023

Tomada RJ11





MA7200
Placa 4x2
Cega



MA7201
Placa 4x2
p/ 1 Módulo
Vertical



MA7202
Placa 4x2
p/ 2 Módulos



MA7203
Placa 4x2
p/ 3 Módulos



MA7204
Placa 4x2
p/ 1 Módulo
Horizontal



MA7205
Placa 4x2
p/ 1 Módulo
Horizontal
Deslocado



MA7207
Placa 4x2
para Chuveiro /
Dimmer ø10mm



MA72011
Placa 4x2
p/ 2 Módulos
Distanciados



MA7440
Placa 4x4
Cega



MA7442
Placa 4x4
p/ 2 Módulos



MA7443
Placa 4x4
p/ 6 Módulos



MA7444
Placa 4x4
p/ 4 Módulos

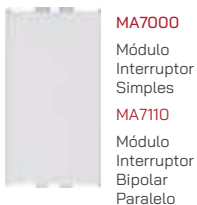

MA7000
Módulo
Interruptor
Simples



MA7010
Módulo
Interruptor
Paralelo



MA7020
Módulo
Pulsador de
Campainha



MA7030
Módulo de
Pulsador de
Minuteria



MA7130
Módulo
Interruptor
Bipolar
Simples



MA7212
Módulo
Cego



MA7213
Módulo com Furo
de ø10mm



MA7220
Módulo
para Cabo
Coaxial



MA7400 - 10A
MA7600 - 20A
Módulo Tomada
2P+T



MA7618
Módulo Dimmer
Bivolt
Automático



MA7619
Módulo
Controle de
Ventilador
Bivolt



MA7819
Módulo Campainha
Bivolt



MA7817
Módulo RJ11



MA7818
Módulo RJ45



MAV7600 - 20A
Módulo
Tomada 2P+T
Vermelha



***USB7822**
Módulo USB
Bivolt 2,1A 5V

linha Volutta

5 ANOS
DE GARANTIA
100% BRASILEIRO



PARA TODOS OS AMBIENTES

Desenvolvida para combinar com todos os ambientes. Com acabamento em alto brilho.

SISTEMA MODULAR

Possibilita diversas instalações

DESIGN MODERNO

Prática, segura, com design moderno e cantos levemente arredondados com um volume

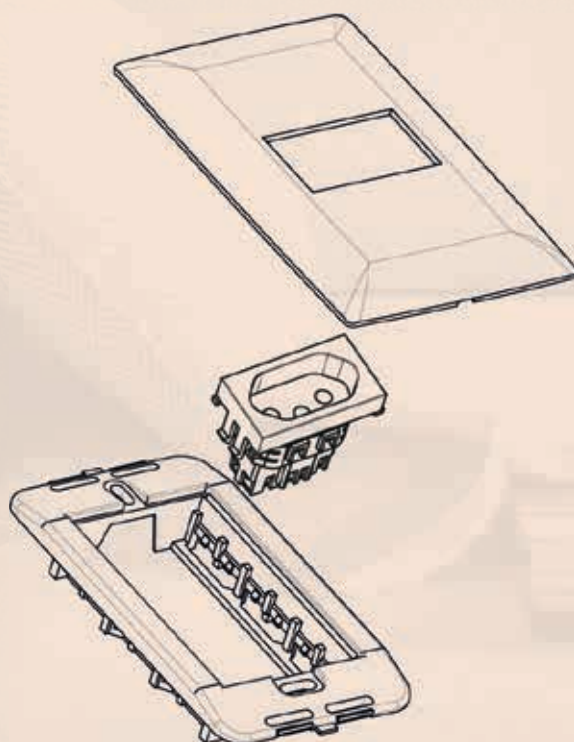



V7001 - 10 A
Interruptor Simples
V2011 - 10 A
Interruptor Paralelo
V2111 - 10 A
Interruptor Bipolar Paralelo



V2151 - 25 A
Interruptor Bipolar Simples



V2131 - 10 A
Interruptor Bipolar Simples



V2021 - 10 A
Pulsador de Campanha



V2031 - 10A
Pulsador de minuteria



V7401 - 10 A
V7601 - 20 A
1 Tomada 2P+T Horizontal



V2101 - 10A
2 Interruptores Simples
V2121 - 10A
2 Interruptores Paralelos
V7011 - 10A
1 Interruptor Simples + 1 Interruptor Paralelo



V2201 - 10 A
3 Interruptores Simples
V2211 - 10 A
3 Interruptores Paralelos
V7043 - 10 A
2 Interruptores Paralelos + 1 Interruptor Simples



V7301 - 10 A
1 Interruptor Simples + 1 Tomada 2P+T
V7311 - 10 A
1 Interruptor Paralelo + 1 Tomada 2P+T



V8001 - 10 A
2 Interruptores Simples + 1 Tomada 2P+T
V8011 - 10 A
2 Interruptores Paralelos + 1 Tomada 2P+T



V7501 - 10 A
1 Tomada 2P+T Vertical



V3601 - 10 A
2 Tomadas 2P+T



V0023
Tomada RJ11

V7200
Placa 4x2
Cega



V7201
Placa 4x2
p/ 1 Módulo
Vertical



V7202
Placa 4x2
p/ 2 Módulos



V7203
Placa 4x2
p/ 3 Módulos



V7204
Placa 4x2
p/ 1 Módulo
Horizontal



V7205
Placa 4x2
p/ 1 Módulo
Horizontal
Deslocado



V7207
Placa 4x2
com Furo de
ø10mm



V7211
Placa 4x2
p/ 2 Módulos
Distanciados



V7440
Placa 4x4
Cega



V7442
Placa 4x4
p/ 2 Módulos



V7443
Placa 4x4
p/ 6 Módulos



V7444
Placa 4x4
p/ 4 Módulos



V7000 - 10A
Módulo
Interruptor
Simples



V7010 - 10A
Módulo
Interruptor
Paralelo



V7020 - 10A
Módulo
Pulsador de
Campainha



V7030 - 10A
Módulo de
Pulsador de
Minuteria



V7130 - 10A
Módulo
Interruptor
Bipolar
Simples



V7212
Módulo
Cego



V7110 - 10A
Módulo
Interruptor
Bipolar Paralelo

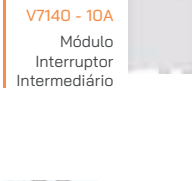

V7140 - 10A
Módulo
Interruptor
Intermediário



V7213
Módulo com
Furo de
ø10mm

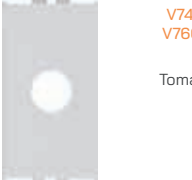

V7400 - 10A
V7600 - 20A
Módulo
Tomada 2P+T



VV7600 - 20A
Módulo
Tomada 2P+T



V7618
Módulo
Dimmer Bivolt
Automático



V7619
Módulo
Controle de
Ventilador
Bivolt



V7819
Módulo
Campainha
Bivolt



V7220
Módulo para
Cabo Coaxial



V7817
Módulo RJ11



V77818
Módulo RJ45



USB7822
Módulo USB
Bivolt 2,1A 5V



linha Bianca

5 ANOS
DE GARANTIA
100% BRASILEIRO



PARA TODOS OS AMBIENTES

Baixo custo com qualidade excepcional e praticidade.

SISTEMA COM PARAFUSOS

O clássico formato com parafusos com alta resistência e durabilidade.

DESIGN REFORMULADO

O básico reformulado. Contornos arredondados com alto brilho.

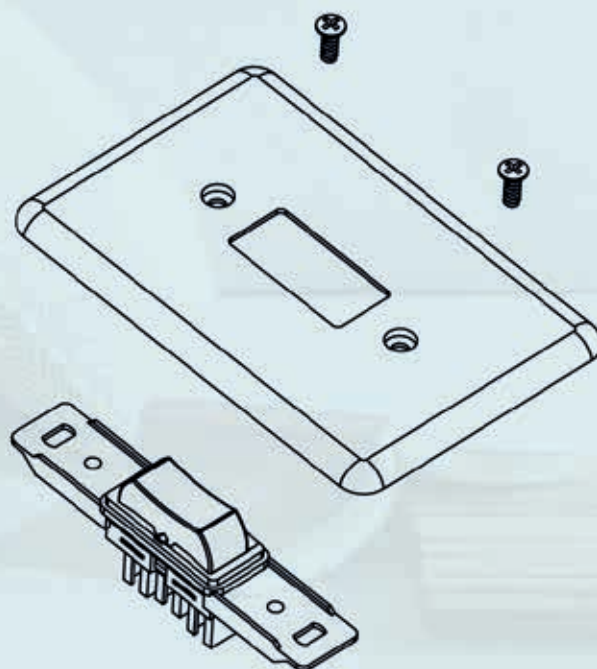

B2001 - 10A
 Interruptor Simples
B2011 - 10A
 Interruptor Paralelo



B2151 - 25A
 Interruptor Bipolar Simples



B2021-10A
 Pulsador de Campainha



B2031 - 10A
 Pulsador de Minuteria



B2131 - 10A
 Interruptor Bipolar Simples



B2111 - 10A
 Interruptor Bipolar Paralelo
B2141 - 10A
 Interruptor Intermediário



B2101 - 10A
 2 Interruptores Simples
B2121 - 10A
 2 Interruptores Paralelos



B2201 - 10A
 3 Interruptores Simples
B2211 - 10A
 3 Interruptores Paralelos



B7301 - 10A
B7801 - 20A
 1 Interruptor Simples + Tomada 2P+T
B7311 - 10A
B7811 - 20A
 1 Interruptor Paralelo + Tomada 2P+T



B8001 - 10A
B9001 - 20A
 2 Interruptores Simples + Tomada 2P+T
B8011 - 10A
B9011 - 20A
 2 Interruptores Paralelos + Tomada 2P+T



B7401 - 10A
B7601 - 10A
B7601 - 20A
 Tomada 2P+T Horizontal



B7501 - 10A
B7701 - 20A
 Tomada 2P+T Vertical



B3601 - 10A
B4601 - 20A
 2 Tomadas 2P+T



B0023
 Tomada RJ45



B4210
 Campainha Bivolt de Embutir



B4220
 Tomada para Cabo Coaxial





BE8800
Placa Cega
Redonda Ext.
117mm p/
Caixa Redonda



BE4200
Placa 4x2
Cega



BE4201
Placa 4x2 p/
1 Interruptor



BE4202
Placa 4x2 p/
2 Interruptores



BE4203
Placa 4x2 p/
3 Interruptores
ou
1 Tomada RJ11
ou Tomadas
7700 e 7500



BE4207
Placa 4x2
com Furo de
ø10mm



BE5201
Placa 4x2 p/
1 Tomada
2P+T Vertical



BE5204
Placa 4x2 p/
1 Tomada
2P+T
Horizontal



BE5202
Placa 4x2 p/
2 Tomadas
2P+T
Distanciadas



BE5203
Placa 4x2 p/
2 Interruptores
+ Tomada 2P+T



BE5205
Placa 4x2 p/
1 Interruptores +
1 Tomada 2P+T



BE4205
Placa 4x2 p/
1 Tomada de
Telefone



BE4430
Placa 4x4 p/
Tomada p/
Telefone +
Tomada p/ Cabo
Coaxial



BE4400
Placa 4x4
Cega



BE4407
Placa 4x4 p/
com Furo de
ø10mm



BE4410
Placa 4x4 para
1 Tomada de
Telefone



BE4455
Placa 4x4 para
2 Tomadas de
Telefone



BE4411
Placa 4x4 p/
com Furo de
2 Interruptores
de uma Tecla



BE4456
Placa 4x4 p/
1 Tomada de
Telefone +
Furo de
ø10mm



BE4420
Tomada para
Cabo Coaxial

BE4412

Placa 4x4 p/
1 Interruptor de
uma Tecla +
1 Interruptor de
duas Teclas



BE4422

Placa 4x4 p/
2 Interruptores
de duas Teclas



BE4415

Placa 4x4 p/
1 Interruptor
de uma Tecla
+ 1 Tomada de
Telefone



BE4401

Placa 4x4 p/
1 Interruptor de
uma Tecla +
1 Tomada 2P+T



BE4435

Placa 4x4 p/
1 Interruptor de
três Teclas
+ 1 Tomada de
Telefone



BE4425

Placa 4x4 p/
1 Interruptor
de duas Teclas
+ 1 Tomada de
Telefone



BE4402

Placa 4x4 p/
1 Interruptor de
duas Teclas +
1 Tomada 2P+T



BE4403

Placa 4x4 p/
1 Interruptor de
três Teclas
+ 1 Tomada 2P+T



BE4405

Placa 4x4 p/
1 Tomada 2P+T
+ Furo de
ø10mm



BE4404

Placa 4x4 p/
2 Tomadas
2P+T



BE4433

Placa 4x4 p/
2 Interruptores
de três Teclas
ou RJ11



BE4444

Placa 4x4 para
4 Tomadas
2P+T



Mecanismos compatíveis com Bianca e placas condutes do mercado

B2130 - 10A

Interruptor
Bipolar
Simples



B2000 - 10A

Interruptor
Simples



B2020 - 10A

Pulsador de
Campainha



B2030 - 10A

Pulsador de
Minuteria



B2110 - 10A

Interruptor
Bipolar
Paralelo



B2100 - 10A

2 Interruptores
Simples



B2120 - 10A

2 Interruptores
Paralelos



B2200 - 10A

3 Interruptores
Simples



B2210 - 10A

3 Interruptores
Paralelos



B7500 - 10A /
B7700 - 20 A

Tomada 2P+T
Vertical



B7700V

Tomada 2P+T
Vertical Vermelha
(Compatível com
Conduletes)





BC4200
Placa Cega



BC4201
Placa para
1 Interruptor de
uma Tecla



BC402
Placa para
1 Interruptor de
duas Teclas



BC4203
Placa para
1 Interruptor de
três Teclas
ou
Tomada RJ11



BC4205
Placa para
Tomada de
Telefone



BC5202
Placa para 2
Tomadas 2P+T
Distanciadas



BC5203
Placa para 1
Interruptor de
duas Teclas +
Tomada 2P+T



BC5205
Placa para
1 Interruptor de
uma Tecla +
Tomada 2P+T



B8000 - 10A
B9000 - 20A
2 Interruptores
Simples +
Tomada 2P+T
B8010 - 10A
B9010 - 20A
2 Interruptores
Paralelos +
Tomada 2P+T



B7300 - 10A
B7800 - 20A
1 Interruptor
Simples +
Tomada 2P+T
B7310 - 10A
B7810 - 20A
1 Interruptor
Paralelo +
Tomada 2P+T



B7400 - 10A
B7600 - 20A
Tomada 2P+T
Horizontal
**Item não
compatível com
B.Condulete**



B3600 - 10A
B4600 - 20A
2 Tomadas 2P+T



B7818
Tomada RJ45
sem placa



MÓDULO BIANCA

Mecanismos projetados para serem intercambiáveis entre Bianca e B.Condulete



linha XB

5 ANOS
DE GARANTIA
100% BRASILEIRO



LINHA EXTERNA

Mais praticidade para instalações externas.

ALTO BRILHO

Acabamento em alto brilho, valorizando as peças.

DESIGN PRECISO

Cantos levemente arredondados na forma quadriculada.

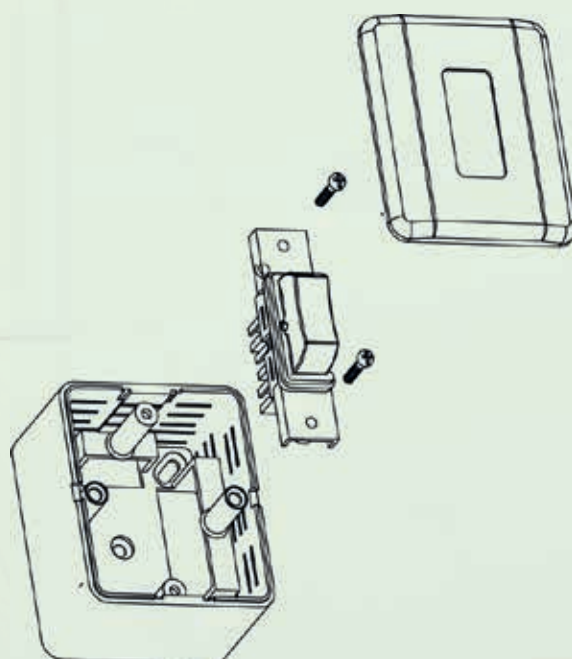



XBC2001 - 10A
Interruptor Simples
XBC2011 - 10A
Interruptor Paralelo



XBC2151 - 25A
Interruptor Bipolar
Simples



XBC2021 - 10A
Pulsador de
Campainha



XBC2131 - 10A
Interruptor
Bipolar Simples



XBC2111 - 10A
Interruptor
Bipolar Paralelo
XBC2141 - 10A
Interruptor
Intermediário



XBC2031 - 10A
Pulsador de
Minuteria



XBC2101 - 10A
2 Interruptores
Simples
XBC2121 - 10A
2 Interruptores
Paralelo



XBC2201 - 10A
3 Interruptores
Simples
XBC2211 - 10A
3 Interruptores
Paralelos



XBC7301 - 10A
XBC7801 - 20A
1 Interruptor
Simples
+ 1 Tomada
2P+T
XBC7311 - 10A
XBC7811 - 20A
1 Interruptor
Paralelo
+ 1 Tomada
2P+T



XBC7401 - 10A
XBC7601 - 20A
Tomada 2P+T
Horizontal



XBC7501 - 10A
XBC7701 - 20A
Tomada 2P+T
Vertical



XBC7701V - 10A
Tomada 2P+T
Vertical
Vermelha



XBC3601 - 10A
XBC4601 - 20A
2 Tomadas
2P+T



XBC4220
Tomada para
Cabo Coaxial



XBC1018
Tomada Padrão
Duplo Jack



XBC2900
Placa Cega
+ Caixa



XBC2908
Placa para
Antena ø10mm
+ Caixa

MEDIDAS

linha Lissê

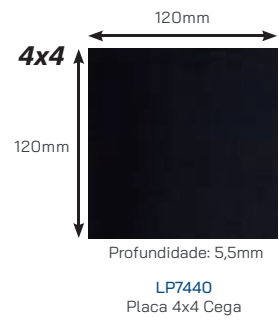
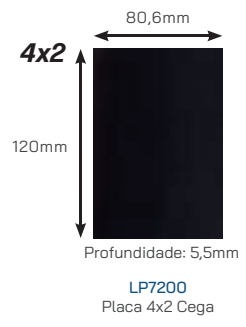
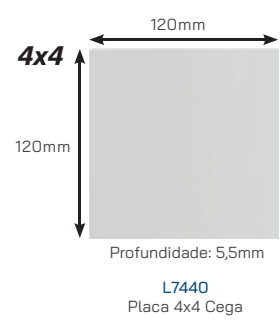
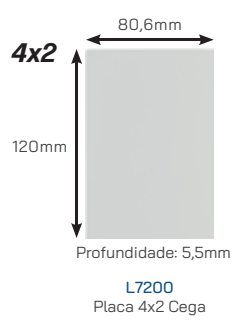

linha Lissê.X Placas para Condulete

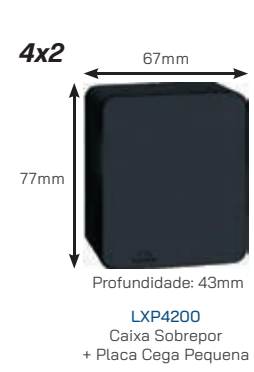
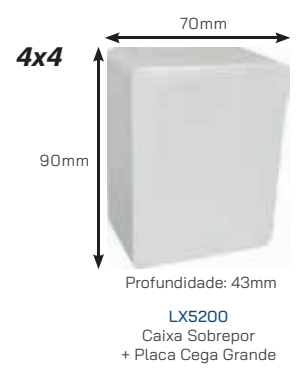
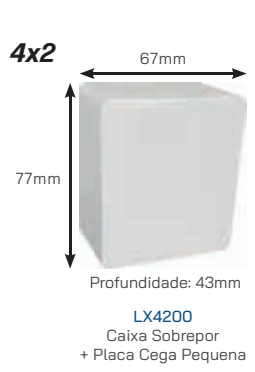

linha Lissê.m Suporte para Móveis

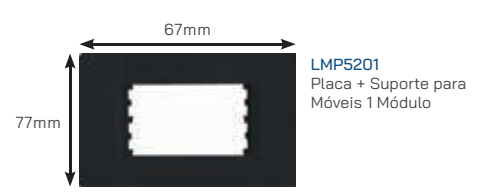
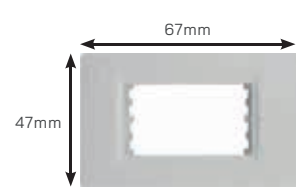

linha Lissê.pass

Placas para Condutele



LPB4200
Placa para
Condutele Cega

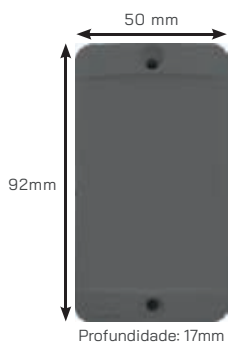

LPC4200
Placa para
Condutele Cega



LPP4200
Placa para
Condutele Cega

linha Bianca

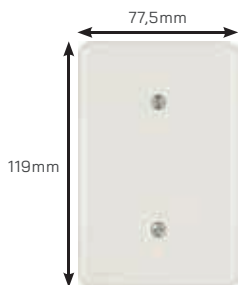

4x2
BE4200
Placa 4x2 Cega

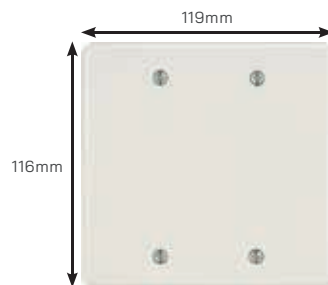

4x4
BE4400
Placa 4x4 Cega

linha Moduluz

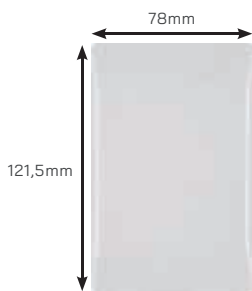

4x2
V7200
Placa 4x2
Cega

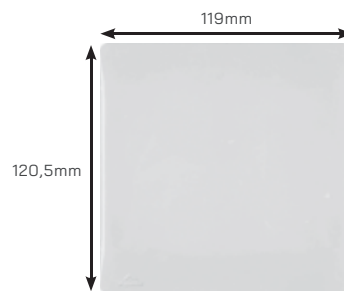

4x4
V7200
Placa 4x4
Cega

linha Volutta

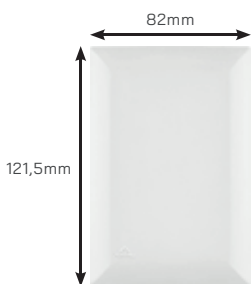

4x2
BE4200
Placa 4x2
Cega

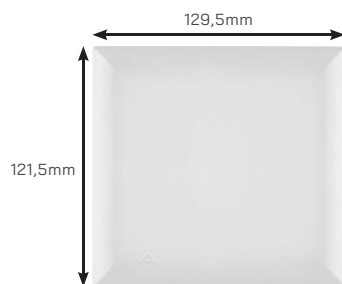

4x4
BE4400
Placa 4x4
Cega

linha XB

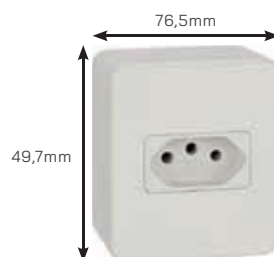

XBC7401
Tomada 2P+T
Horizontal

linha
Acessórios

SENSORES DE PRESENÇA

PLUGUES DESMONTÁVEIS

LUMINÁRIAS

PLAFONS

SOQUETES

CAMPAINHA

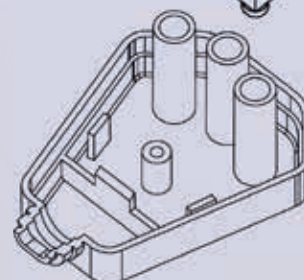
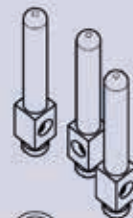
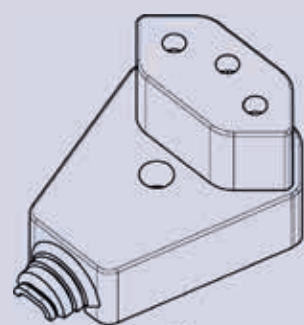
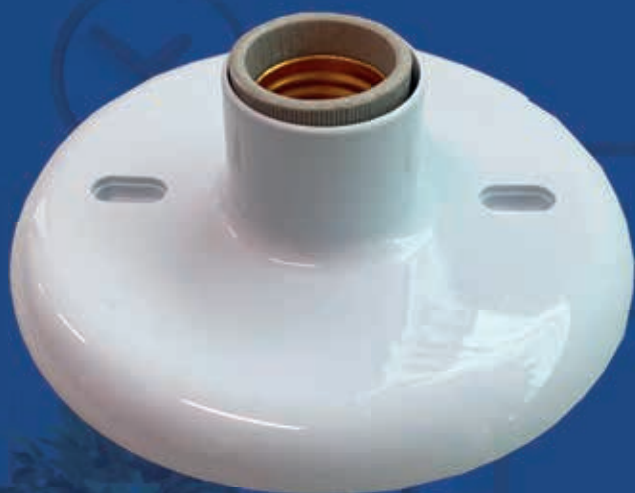



TMP7400 - 10A
TMP7400 - 20A
Tomada 2P+T
Desmontável para
Extensão
(Pino Fêmea)
Preto



TMB7400 - 10A
TMB7600 - 20A
Tomada 2P+T
Desmontável para
Extensão
(Pino Fêmea)
Branco



PL10P - 10A
PL20P - 20A
Plugue Móveis
Desmontável
2P (Pino Macho)
Preto



PL10B - 10A
PL20B - 20A
Plugue Móveis
Desmontável 2P
(Pino Macho)
Branco



PL18010P - 10A
PL18020P - 20A
Plugue Móveis
Desmontável 180°
2P+T (Pino Macho)
Preto



PL18010B - 10A
PL18010B - 20A
Plugue Móveis
Desmontável 180°
2P+T (Pino Macho)
Branco



PL9010B - 10A
PL9020B - 20A
Plugue Móvel
Desmontável
Branco 90° 2P+T
(Pino Macho)



PL9010P - 10A
PL9020P - 20A
Plugue Móvel
Desmontável
Branco 90°
2P+T (Pino Macho)



B3500B
Campainha
Externa



EX3000 - 10A
Interruptor
Simples
(Branco)



EX3020 - 10A
Pulsador de
Campainha
(Branco)



EX7400 - 10A
EX7600 - 20A
Tomada 2P+T
(Branco)

AD5000P - 10A
Adaptador de
Conversão de
Sistemas 2P
(Preto)



AD5000B-10A
Adaptador de
Conversão de
Sistemas 2P
(Branco)



USB7822
Módulo USB
Bivolt 2,1A 5V

(Compatível
com todas
as linhas
modulares
APOIO)



**3600B (127V)
3700B (220V)**

Campainha
Dim-Dom
Branca



B309

Luminária Tartaruga
Oval Branca para
Lâmpada 15W



A309

Luminária Tartaruga
Oval Preta para
Lâmpada 15W



7902

Sensor de
Presença
de Sobrepor
Bivolt
Automático

Deteção em
120°
por Fotocel. e
Infravermelho



7901

Sensor de
Presença de
Embutir Bivolt
Automático

Deteção em
180°
por Fotocel. e
Infravermelho



7908

Sensor de
Presença de
Teto Bivolt
Automático

Deteção em
360°
por Fotocel. e
Infravermelho



B107

Plafonier
Decorativo para
1 Lâmpada 60W
+ Soquete de
Cerâmica



A107

Plafonier
Decorativo para
1 Lâmpada 60W
+ Soquete de
Cerâmica

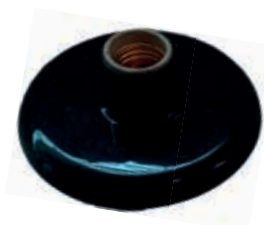

AS5900

Soquete de Cerâmica
4A Borne de Latão





Eixo+Porcas+Anilhas+Buchas

Cód.	Especificação	Quantidade	Embalagem
8388	ø8mm	02	Saco
8389	ø10mm	02	Saco



Parafusos+Buchas

Cód.	Especificação	Quantidade	Embalagem
8101	ø 5mm	06	Blister
8606	ø 5mm	100	Caixa
8102	ø 6mm	06	Blister
8607	ø 6mm	100	Caixa
8103	ø 7mm	06	Blister
8608	ø 7mm	100	Caixa
8104	ø 8mm	04	Blister
8609	ø 8mm	50	Caixa
8105	ø 10mm	03	Blister
8610	ø 10mm	25	Caixa



Parafuso+ Bucha para Tijolo Baiano

Cód.	Especificação	Quantidade	Embalagem
8106	ø 6mm	02	Blister
8581	ø 6mm	100	Saco
8107	ø 8mm	02	Blister
8582	ø 8mm	100	Saco
8583	ø 10mm	50	Saco



Ganchos+Buchas com Anel

Cód.	Especificação	Quantidade	Embalagem
8108	ø 6mm	04	Blister
8611	ø 6mm	50	Caixa
8111	ø 8mm	02	Blister
8614	ø 8mm	25	Caixa



Escápulas+Buchas com Anel

Cód.	Especificação	Quantidade	Embalagem
8109	ø 6mm	04	Blister
8612	ø 6mm	50	Caixa
8112	ø 8mm	02	Blister
8615	ø 8mm	25	Caixa



Pitõe+Buchas com Anel

Cód.	Especificação	Quantidade	Embalagem
8110	ø 6mm	04	Blister
8613	ø 6mm	50	Caixa
8113	ø 8mm	02	Blister
8616	ø 8mm	25	Caixa



Buchha Plástica com Anel

Cód.	Especificação	Quantidade	Embalagem
8551	ø 6mm	200	Saco
8552	ø 8mm	100	Saco
8553	ø 10mm	50	Saco



Buchha Plástica com Anel

Cód.	Especificação	Quantidade	Embalagem
8056	ø 5mm	06	Blister
8057	ø 6mm	06	Blister
8058	ø 7mm	06	Blister
8059	ø 8mm	06	Blister
8060	ø 10mm	06	Blister
8061	ø 12mm	03	Blister



Buchha Plástica para Gesso

Cód.	Especificação	Quantidade	Embalagem
8560	4 - 16 mm	50	Saco
8561	15 - 23 mm	50	Saco
8562	24 -32 mm	50	Saco



Buchha Plástica

Cód.	Especificação	Quantidade	Embalagem
8050	ø 5 mm	10	Blister
8600	ø 5 mm	200	Caixa
8051	ø 6 mm	10	Blister
8601	ø 6 mm	200	Caixa
8052	ø 7 mm	06	Blister
8602	ø 7 mm	100	Caixa

Cód.	Especificação	Quantidade	Embalagem
8053	ø 8 mm	06	Blister
8603	ø 8 mm	100	Caixa
8054	ø 10 mm	06	Blister
8604	ø 10 mm	50	Caixa
8055	ø 12 mm	03	Blister
8605	ø 12 mm	25	Caixa



Fixadores

Cód.	Especificação	Quantidade	Embalagem
8114	2,5 mm	15	Blister
8617	2,5 mm	150	Caixa
8115	1,5 mm	15	Blister
8618	1,5 mm	150	Caixa
8116	1,0 mm	15	Blister
8619	1,0 mm	150	Caixa



5 ANOS
DE GARANTIA
100% BRASILEIRO



WWW.APOIO.IND.BR



(11) 3386-7402



(11) 91367-1499



apoio.ind.br

SAC@APOIO.IND.BR / VENDAS@APOIO.IND.BR